

## SONEIL

6033 Shawson Dr., Unit 29, Mississauga  
Ontario, Canada L5T 1H8, Email: info@soneil.com  
Ph.: 905 565 0360 Fax: 905 565 0352  
Visit us on the web at <http://soneil.com>



---

# SPECIFICATIONS - 2403SRL CHARGER

## Totally Automatic Switch-Mode Battery Chargers

"Suitable for Gel, Sealed & Wet Lead Acid Batteries"

**Summary:** 24 Volts, 2 Amp Constant Current  
(equivalent to 4 A tapered charger in charging time)

- **Universal Input 90VAC to 264VAC** - Suitable anywhere in the world.
- Automatic Cut-off and then true Float. Can be left connected indefinitely without harming the battery.
- **De-sulfation of battery**
- **UL, CSA, CE Listed.**
- Meets FCC Class B; EN55022 Class B.
- Can also be used for On-board (internal) applications.
- Increases battery life by de-sulfating the battery.
- Many advance features described in this spec.
- **Very small size and very light weight**

## **Explanation of the Features:**

The advance technology of the OEM Battery Chargers supplied by Soneil is fundamentally different from other battery chargers. The conventional linear battery charger is an electrical device whereas the 2403SRL is a light weight sophisticated electronic device.

### 1. **Switch-Mode Technology:**

Most of the battery chargers use linear technology, which convert the 115/230 VAC to 24 VDC at 60 or 50 Hz. This requires a large transformer, which has the disadvantage of lower efficiency resulting in higher heat generation, larger size and weight.

Soneil's Battery Charger transforms the 115/230 VAC into 24 VDC at 100,000 Hz (1667 times faster than conventional charger) which requires a much smaller

transformer and this results in a unit of smaller size, low weight and improved efficiency.

The 2403SRL uses sophisticated electronic circuitry with microchips. All present day computers use switch-mode technology.

2. **International Safety Approvals & Listing:**

Both North American (UL & cUL) and European (CE) approvals in a single charger.

3. **Input Requirements:** Universal Input

- a) 90VAC to 264VAC
- b) 47 - 63 Hz

Very wide AC input tolerance. **Suitable for every part of the world.**

4. **Output:**

2 Amps Constant Current @ 24 Volts DC  
(Equivalent to 4 Amps tapered charger in charging time)

- a) Line Regulation @ Full Load 2%
- b) Load Regulation @ 3%
- c) **Ripple Voltage:** Very low

The peak to peak ripple voltage into a resistive load is less than 200mV for the output voltage above 24 VDC.

## 5. Charging Cycle:

The charging curve is attached. The explanation of the charging cycle is as following.

Stages	Condition	Mode*	Current	Voltage	LED Indication
Stage 1	Charging Pulse mode	Pulse mode	1.5A Pulsing	0.5V to 5.0V	Flash
Stage 2	Constant Current mode	CC mode	1.5A	5.0V to 28.8.V	Orange
Stage 3	Constant Voltage mode	CV mode	Reduces from 1.5A***	Holds at 28.8V	Orange
Stage 4	Standby Voltage mode	Standby CV mode	Reduces to zero	Maintains 27.6V	Green
	Recharging mode	CC mode	1.5A	27.6V	Orange

\* CC mode = Constant current charge

\* CV mode = Constant voltage charge

\*\*\* See Stage 3 description below

#### **Stage 1: Deep Discharge Charging Pulse Mode: LED Flash**

The charger starts charging at 0.5V and give pulse current up to 5V. This has effect of removing loose sulphation formed during deep discharge state of the battery.

#### **Stage 2: Constant Current Mode (CC): LED Orange**

The charger changes to constant current 2 A. When the battery voltage reaches up to 28.8V, the charging stage changes from CC (Constant Current) to CV (Constant Voltage) mode.

#### **Stage 3: Constant Voltage Mode (CV): LED Orange**

The charger holds the battery at 28.8V and the current slowly reduces. When the current reaches at 0.10CC (CC=Constant Current), this point called the Switching Point. The Switching Point is one of the great feature of this battery charger that it can adjust the current automatically according to battery capacity. Other chargers are not capable to adjust the current automatically.

#### **Stage 4: Standby Voltage Mode: LED Green**

The charger maintains the battery voltage at 27.6V and current slowly reduces to zero. Charger can be left connected indefinitely without harming the battery.

#### **Recharging: LED Orange**

If the battery voltage drops down to 27.6V, the charger changes from any mode to Constant Current mode and restart charging. The charging cycle will go through Stage 2 to Stage 4.

**Soneil charger can charge gel, sealed or wet lead acid batteries without use of any switch.**

6. **Two colours and function in one LED:**

LED is used to show the charging status. When the LED is Orange, the charger is in charging or recharging mode and the current is 1.5A constant. When the LED Green, the charger is in Standby mode and no current (zero) is flowing.

7. **Protection:**

- a) **Reverse polarity protection** - provided
- b) **Short circuit protection** - provided
- c) **Over-Voltage Protection** - provided
- d) **Over current protection** - provided
- e) **AC Surge Protection** - provided
- f) **Soft start and stop:** Starts and stops gradually.

No sudden in-rush of current. This protects both the batteries and any other circuits connected to the charger.

8. **De-sulfation of battery:** The charger will remove loose sulfation and increase the battery life. (Hard sulfation cannot be reversed).

9. **No current drain:**

No (zero) current is taken from the battery when connected to battery but AC not plugged in. (Many other chargers in the market draw 30-40 mA which drains the battery.)

10. **Reliability:**

- a) **Mean Time between failures (MTBF):** 50,000 power-on-hours (POH) or greater. This translates into 17 years of everyday operation of 8 hours.
- b) **Burn-in:** All chargers are burned in at an average DC load of 1.5 Amps.

11. **Electromagnetic Interference (EMI):**

The charger will not generate excessive radiated or conducted emissions. No interference with TV, radio, computer or other equipment.

Meets FCC Class B; EN555022 Class B; IEC-801-3 (3V/M from 27MHZ to 1GHZ).

12. **Ground leakage current:**

The ground leakage current is 87 microAmp, which complies with the requirements.

14. **On-board (internal) Feature:** Standard (not an option)

The model has a third output wire, which provides an interlock signal that will prohibit the operation of the vehicle's motor controller whenever the charger is plugged to an AC source.

**Inhibit signal:** The interlock signal is an open circuit output, leakage less than 5 microAmp or less, when the charger is not connected to an AC source. This signal will be less than 50 mV DC while sinking 10 mA when the charger is connected to an AC source.

15. **Size:** **Very Small** Length - 4.7" (119 mm)  
Width - 2.9" ( 73 mm)  
Height - 1.6" ( 41. mm)

**Very Light Weight** 0.5 lbs (220 grams)

Ref: SPEC2403SRL(REV12).14-Jul-03

# CHARGING CURVE MODEL 2403SRL

SONEIL 24V/1.5A CHARGER  
(1.5A CONSTANT CURRENT)

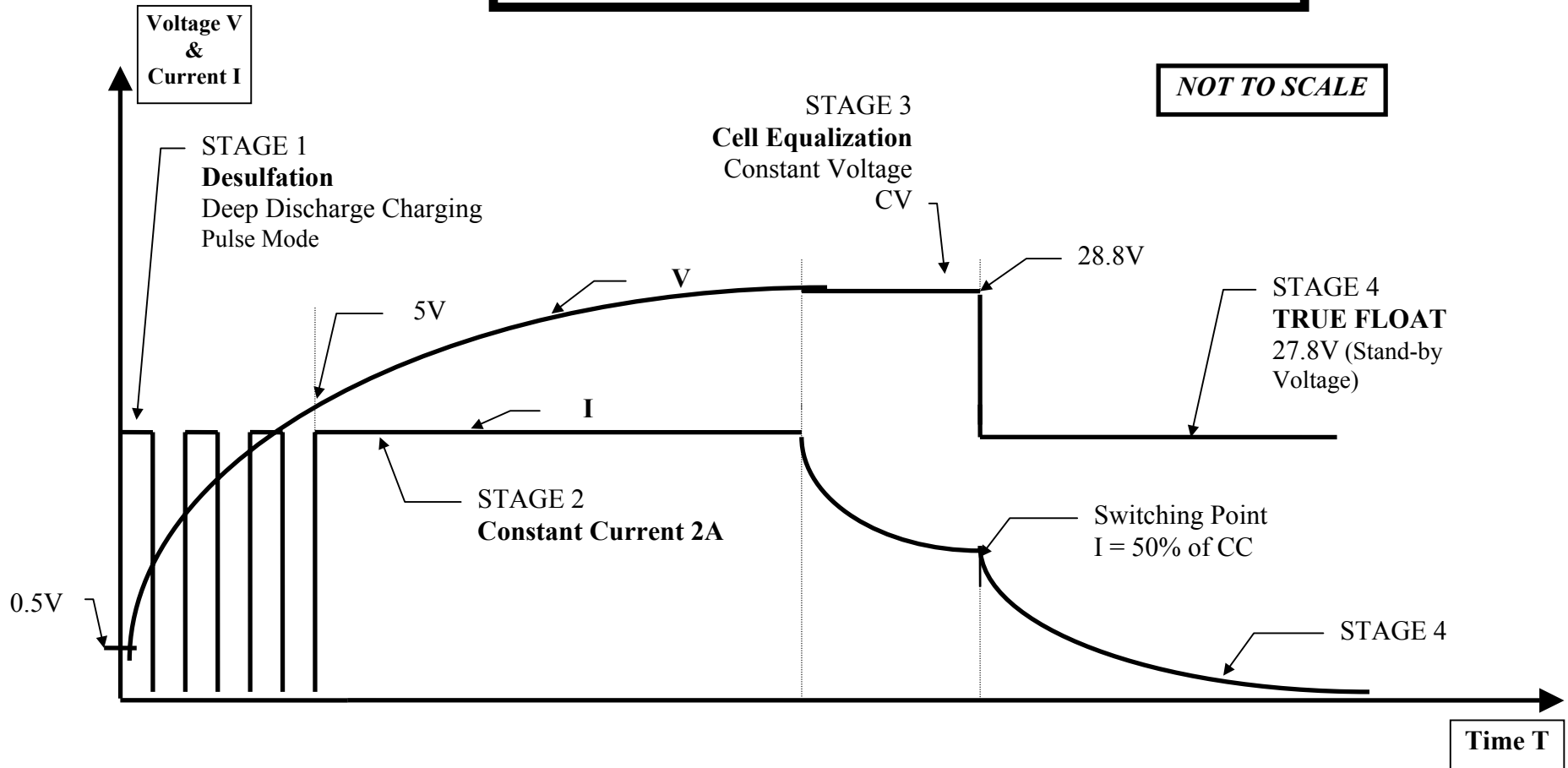

Ref: Curve2403SRL.23-Jan-04

506-2403-D01

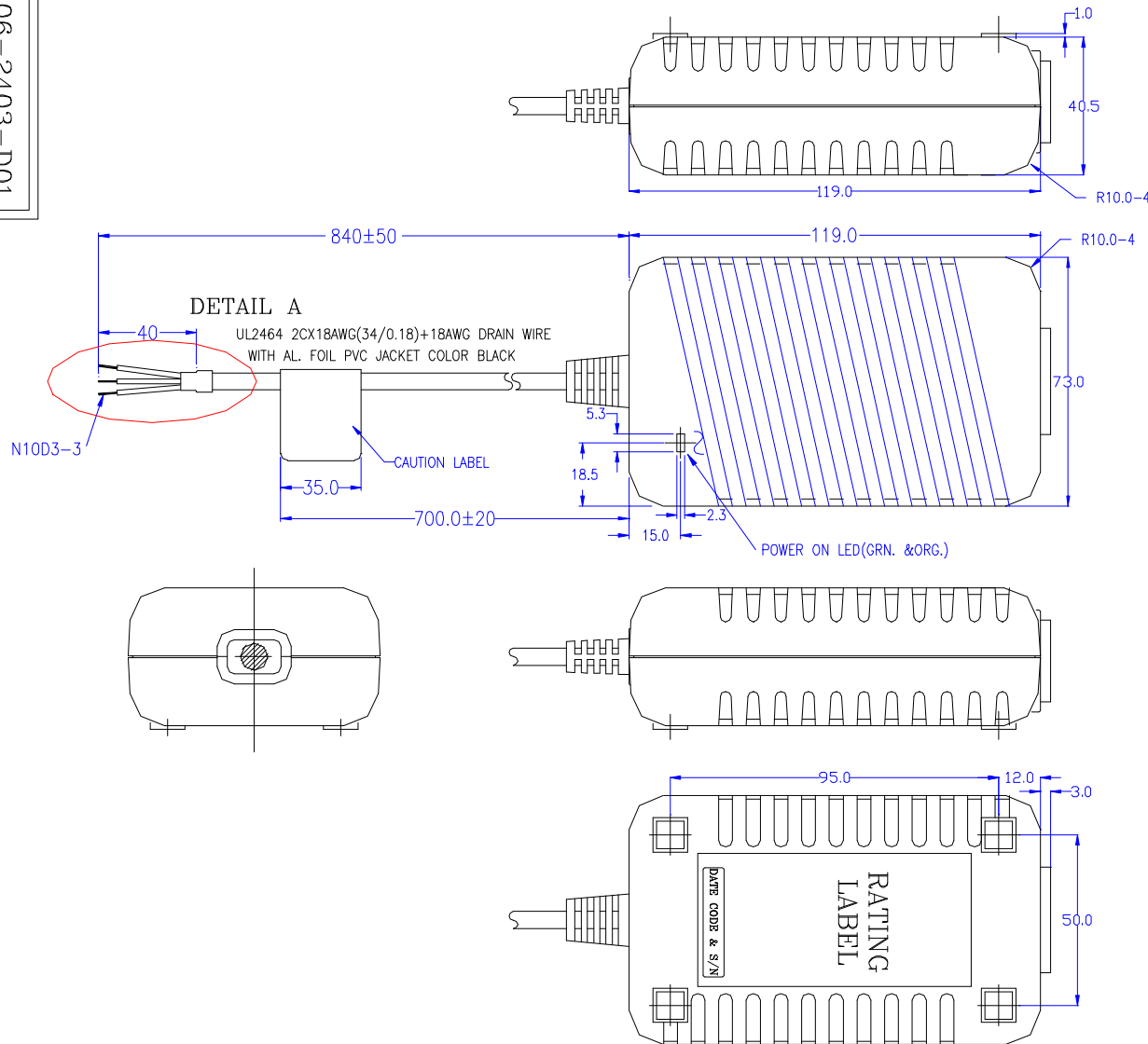

DETAIL A  
DC OUTPUT CONNECTOR

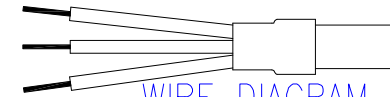

WIRE DIAGRAM  
 COLOR SIGNAL  
 BLACK — GND  
 GREEN — INHIBT  
 WHITE — +24VDC

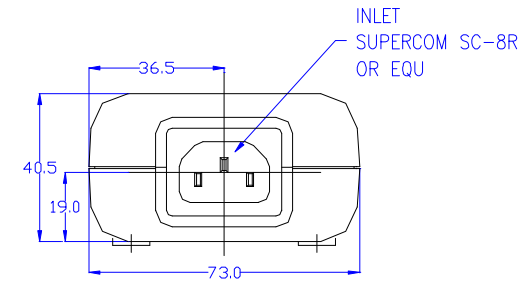

FILE: 1205SR\OUTLINE

ISSUE

SONEIL - MISSISSAUGA ONTARIO CANADA

UNIT mm SCALE SHEET 1 OF 1 R/O/C

TOLERANCE: UNLESS OTHERWISE SPECIFIED

DRAWN DESIGNED CHECKED APPV'D DATE MAY.17.2002

506-2403-D01

TITLE 2403SRD  
ADAPTER

506-2403-DB<sub>2</sub>M

DC OUTPUT CONNECTOR  
DETAIL A

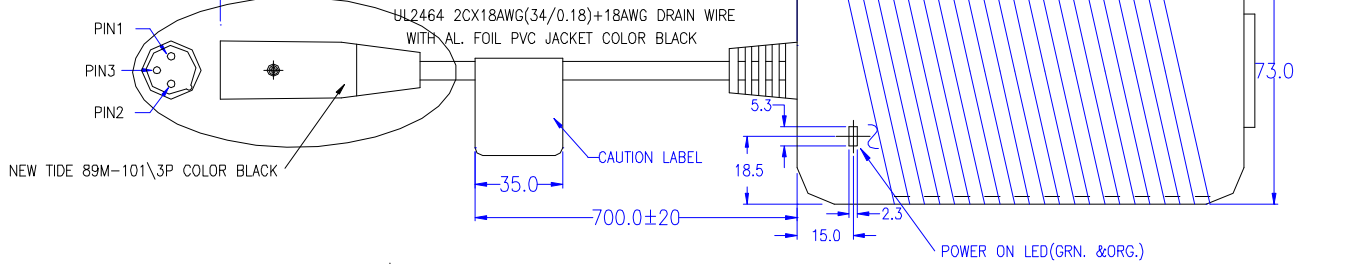

DETAIL A  
DC OUTPUT CONNECTOR

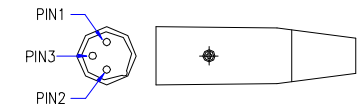

PIN1 : +24V  
PIN2,3 : GND

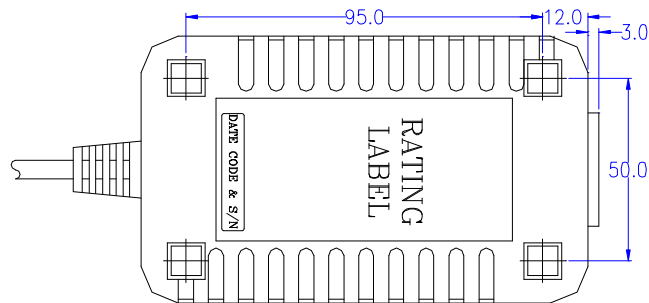
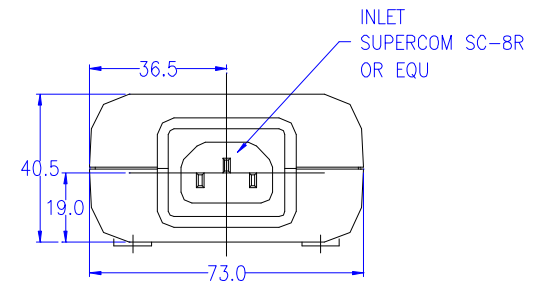
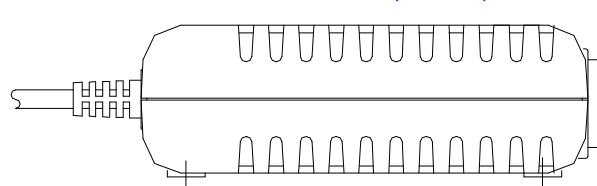
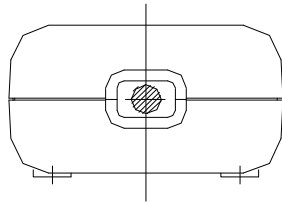

FILE: 1205SR\OUTLINE

ISSUE

SONEIL - MISSISSAUGA ONTARIO CANADA

UNIT mm	SCALE (1X)	SHEET 1 OF 1	R 0 C
TOLERANCE: UNLESS OTHERWISE SPECIFIED		XXX ±0.05	XX ±0.1 X ±0.2 XX ±0.3
DRAWN	DESIGNED	CHECKED	APPV'D
			DATE MAY.17.2002

506-2403-DB<sub>2</sub>M

TITLE 2403SRD-B  
ADAPTER



506-2403-BA1

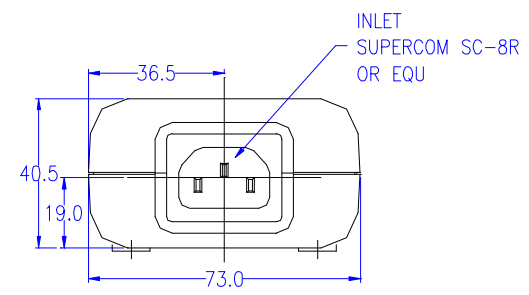
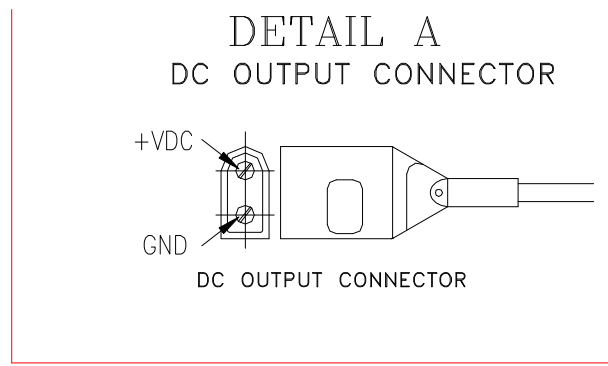
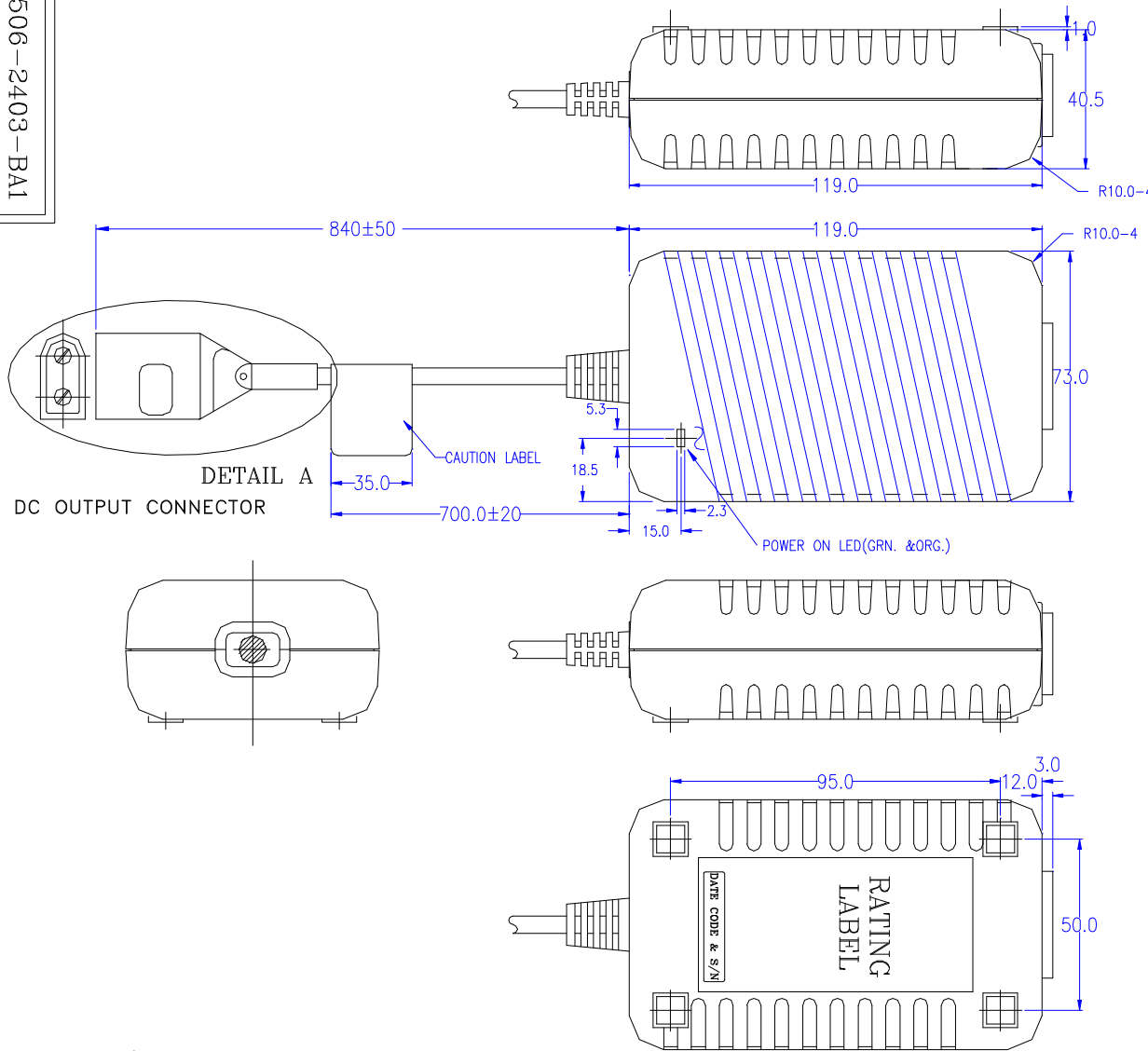

FILE: 1205SR\OUTLINE

ISSUE

SONEIL - MISSISSAUGA ONTARIO CANADA					
UNIT mm	SCALE 1:1	SHEET 1 OF 1	R	O	C
TOLERANCE: UNLESS OTHERWISE SPECIFIED					
	±0.3	±0.2	±0.5	±1.0	±0.3
DRAWN	DESIGNED	CHECKED	APPV'D	DATE	
				MAY.17.2002	

506-2403-BA1
TITLE 2403SRB-A ADAPTER

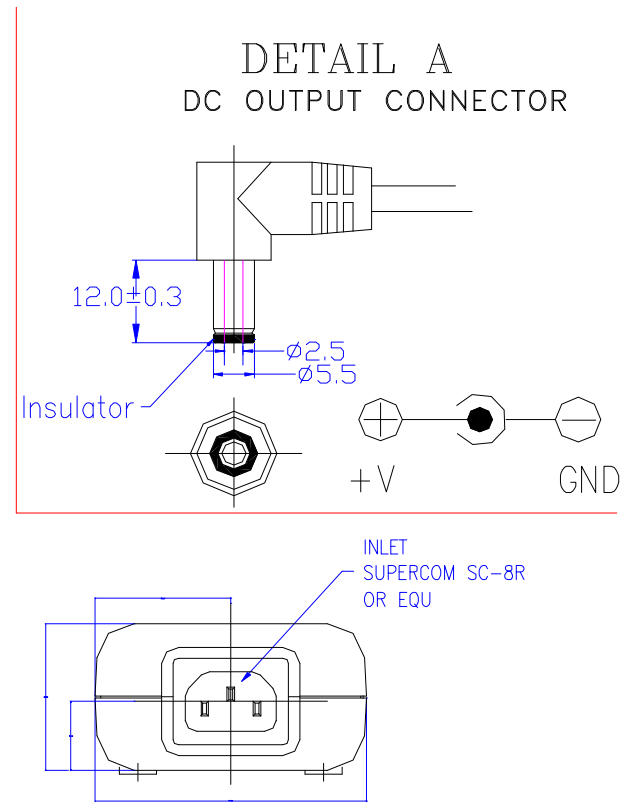
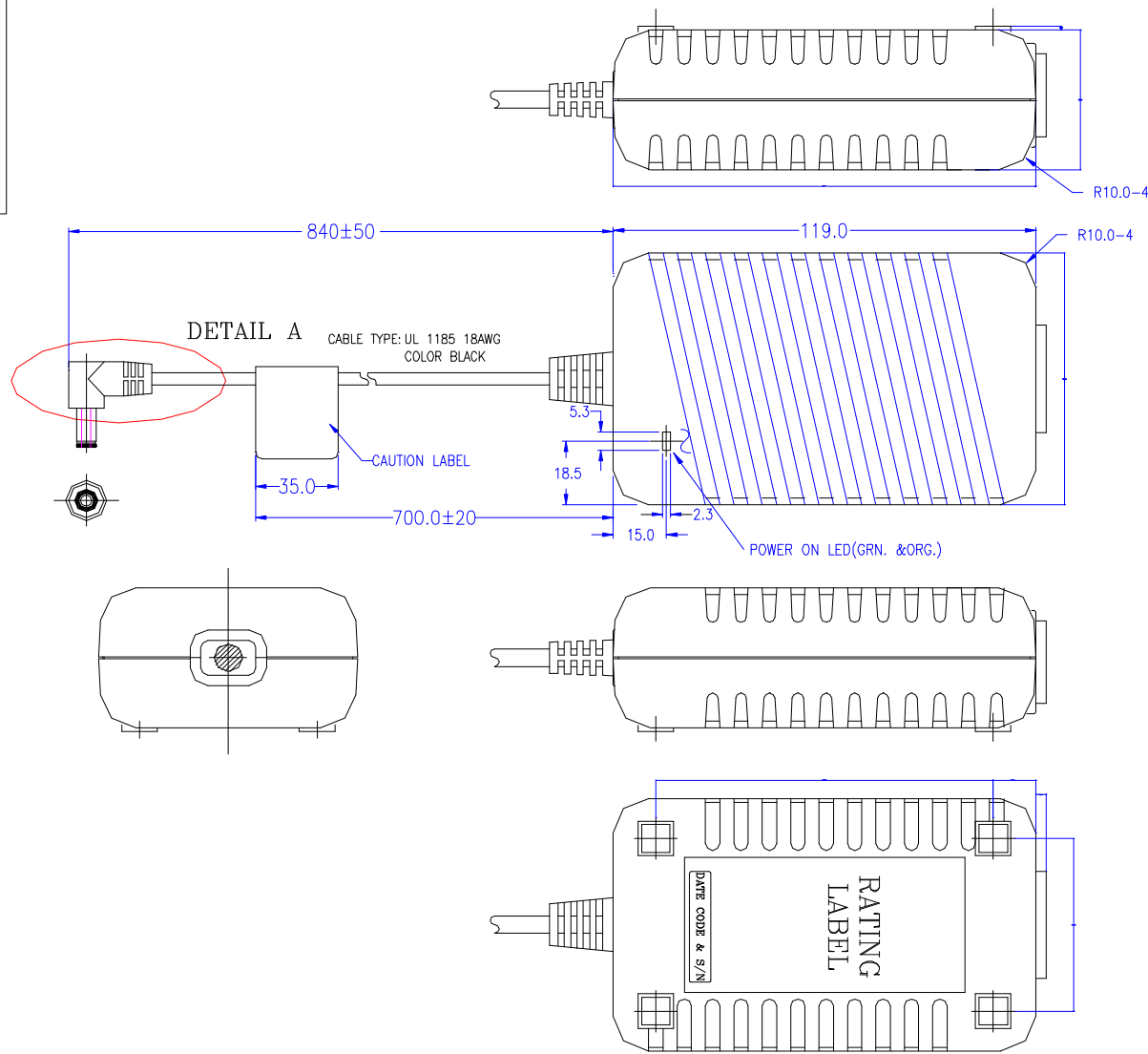

FILE: 1205SR\OUTLINE

SONEIL - MISSISSAUGA CANADA					
UNIT	SCALE	SHEET 1 OF 1	R 0 B		
mm	1:1				
TOLERANCE:					
		XX ±0.2	XX ±0.1	XX ±0.5	XX ±0.3
UNLESS OTHERWISE SPECIFIED: XXX ±0.05					
DRAWN	DESIGNED	CHECKED	APPV'D	DATE	
				MAY.17.2002	

506-2403-DA1M
TITLE 2403SRD-A
ADAPTER